



FRACTIONAL-N SYNTHESIZER WITH INTEGRATED VCO, 1815 - 2010 MHz

Features

- RF Bandwidth: 1815 to 2010 MHz
- Fractional or Integer Modes
- 19-Bit Prescaler
- Ultra Low Phase Noise
-110 dBc/Hz in Band Typ.
- Figure of Merit (FOM)
-227 dBc Integer
- 24-bit Step Size, Resolution 3 Hz typ
- 200 MHz, 14-bit Reference Path Input
- Cycle Slip Prevention
- Read / Write Serial Port, Chip ID
- 40 Lead 6x6mm SMT Package: 36mm²

Typical Applications

- Cellular/4G Infrastructure
- Repeaters and Femtocells
- Communications Test Equipment
- CATV Equipment
- Phased Array Applications
- DDS Replacement
- Very High Data Rate Radios

Functional Diagram

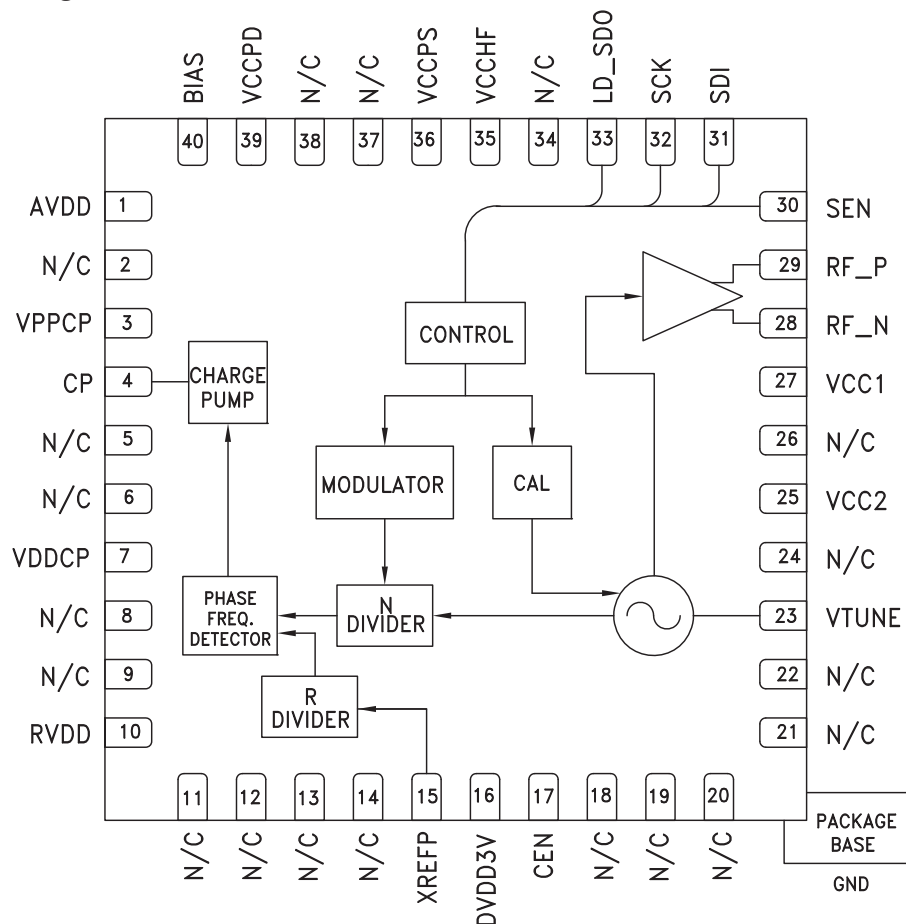

For price, delivery, and to place orders, please contact Hittite Microwave Corporation:
 20 Alpha Road, Chelmsford, MA 01824 Phone: 978-250-3343 Fax: 978-250-3373
 Order On-line at www.hittite.com

**FRACTIONAL-N SYNTHESIZER WITH
INTEGRATED VCO, 1815 - 2010 MHz**
General Description

The HMC831LP6CE is a fully functioned Fractional-N Phase-Locked-Loop (PLL) Frequency Synthesizer with an Integrated Voltage Controlled Oscillator (VCO). The synthesizer consists of an integrated low noise VCO, an autocalibration subsystem for low voltage VCO tuning, a very low noise digital Phase Detector (PD), a precision controlled charge pump, a low noise reference path divider and a fractional divider.

The fractional synthesizer features an advanced delta-sigma modulator design that allows both ultra-fine step sizes and low spurious products. The phase detector (PD) features cycle slip prevention (CSP) technology to allow faster frequency hopping times. Ultra low in-close phase noise and low spurious also allows wider loop bandwidths for faster frequency hopping and low micro-phonics.

For theory of operation and register map refer to the "PLLs w/ Integrated VCOs - RF VCOs" Operating Guide. To view the [Operating Guide](#), please visit www.hittite.com and choose HMC831LP6CE from the "Search by Part Number" pull down menu.

Electrical Specifications, $T_A = +25^\circ\text{C}$

VPPCP, VDDCP, VCC1, VCC2 = 5V \pm 4%; RVDD, AVDD, DVDD3V, VCCPD, VCCHF, VCCPS = 3.3V \pm 6% GNDCP = GNDLS = Ground Paddle = 0V

Parameter	Condition	Min.	Typ.	Max.	Units
RF Output Characteristics					
VCO Frequency at PLL Input	Internal to the IC Only	1815		2010	MHz
RF Output Frequency at f_{VCO}		1815		2010	MHz
RF Output Power at f_{VCO}		4	7.5	11	dBm
VCO Tuning Sensitivity	Measured at 2 GHz, 2V		15		MHz/V
VCO Supply Pushing	Measured at 2 GHz, 2V	-2		1.5	MHz/V
RF Output 2nd Harmonic			-25		dBc
RF Output 3rd Harmonic			-23		dBc
RF Output 4th Harmonic			-31		dBc
RF Divider Characteristics					
19-Bit N-Divider Range (Integer)	Max = $2^{19} - 1$	16		524,287	
19-Bit N-Divider Range (Fractional)	Fractional nominal divide ratio varies (-3 / +4) dynamically max	20		524,283	
REF Input Characteristics					
Max Rep Input Frequency		200			MHz
Max Ref Frequency with AutoCal			TBD		MHz
Min Ref Input Frequency			100		kHz
Ref Input Range	AC Coupled	1.5	2	3.3	Vpp
Ref Input Capacitance				5	pF
14-Bit R-Divider Range		1		16,383	
Phase Detector (PD)					
PD Frequency Fractional Mode	Max PD Freq. Min VCO Freq/20	0.1		TBD	MHz
PD Frequency Integer Mode	Max PD Freq. Min VCO Freq/16	0.1		110	MHz
Charge Pump					
Max Output Current			2.54		mA
Min Output Current			20		μ A
Charge Pump Gain Step Size (5-Bits)			20		μ A
Charge Pump Trim Step Size (4-Bits)			5		μ A

**FRACTIONAL-N SYNTHESIZER WITH
INTEGRATED VCO, 1815 - 2010 MHz**
Electrical Specifications (Continued)

Parameter	Condition	Min.	Typ.	Max.	Units
Charge Pump Trim Step Size (3-Bits)			7		μA
Charge Pump Offset Step Size (4-Bits)			55		μA
PD/Charge Pump Noise	50 MHz Ref, Input Referred, Integer, add 6 dB for Fractional				
1 kHz			-141		dBc/Hz
10 kHz			-149		dBc/Hz
100 kHz			-155		dBc/Hz
Compliance Voltage	Less than 3 dB degradation typ. at these limits				
	-385 μA Offset	0.4		VPPCP-0.8	V
	+385 μA Offset	0.8		VPPCP-0.4	V
Logic Inputs					
VIH Input High Voltage		DVDD3V-0.4		DVDD3V	V
VIL Input Low Voltage		0		0.4	V
Logic Outputs					
VOH Output High Voltage		DVDD3V-0.4		DVDD3V	V
VOL Output Low Voltage		0		0.4	V
Power Supply Voltages					
Analog 3.3V Supplies	AVDD, VCCHF, VCCPS, VCCPD, RVDD	3.0	3.3	3.5	V
Digital Supply	DVDD3V	3.0	3.3	3.5	V
Analog 5V Supplies	VPPCP, VDDCP, VCC1, VCC2	4.8	5	5.2	V
Power Supply Currents					
+5V Analog Charge Pump	VPPCP, VDDCP		5.3		mA
+5V VCO Core and PLL Buffer	VCC2		56		mA
+5V VCO Divider and RF Buffer	VCC1		36		mA
+3.3V Analog	AVDD, VCCHF, VCCPS, VCCPD, RVDD		45		mA
+3.3V Digital	DVDD3V		6.5		mA
Power Down - Crystal Off	Reg 01h=0, Crystal Not Clocked		10		μA
Power Down - Crystal On, 100 MHz	Reg 01h=0, Crystal Clocked 100 MHz		10	200	μA
Power on Reset					
Typical Reset Voltage on DVDD			700		mV
Min DVDD Voltage for No Reset		1.5			V
Power on Reset Delay			250		μs
VCO Open Loop Phase Noise at fo					
10 kHz Offset			-88		dBc/Hz
100 kHz Offset			-118		dBc/Hz
1 MHz Offset			-143	-141	dBc/Hz
10 MHz Offset			-162		dBc/Hz
100 MHz Offset			-170		dBc/Hz
Closed Loop Phase Noise PLL + VCO at fvco/2					
Integer, 50 MHz PFD	1 kHz Offset		-105		dBc/Hz

For price, delivery, and to place orders, please contact Hittite Microwave Corporation:
20 Alpha Road, Chelmsford, MA 01824 Phone: 978-250-3343 Fax: 978-250-3373
Order On-line at www.hittite.com



FRACTIONAL-N SYNTHESIZER WITH INTEGRATED VCO, 1815 - 2010 MHz

Electrical Specifications (Continued)

Parameter	Condition	Min.	Typ.	Max.	Units
Integer, 50 MHz PFD	10 kHz Offset		-112		dBc/Hz
Integer, 50 MHz PFD	100 kHz Offset		-120		dBc/Hz
Integer, 50 MHz PFD	1 MHz Offset		-103		dBc/Hz
Fractional, 50 MHz PFD	10 kHz Offset		-107		dBc/Hz
Fractional, 50 MHz PFD	100 kHz Offset		-112		dBc/Hz
Figure of Merit	Normalized 1 Hz				
Integer Mode	Measured w/ 50 MHz PD at 30 kHz Offset		-227		dBc/Hz
Fractional Mode	Measured w/ 50 MHz PD at 30 kHz Offset		-225		dBc/Hz

12

Closed Loop Integer Phase Noise

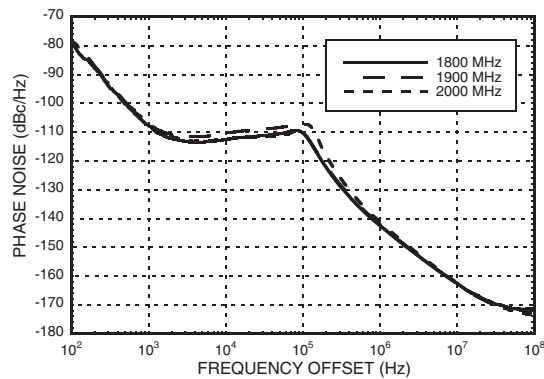

Typical Closed Loop Fractional Phase Noise [1]

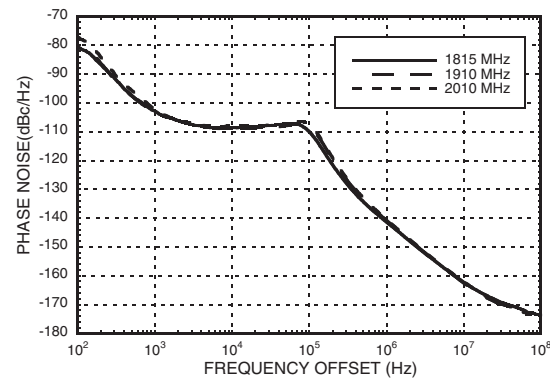

VCO Free Running Phase Noise

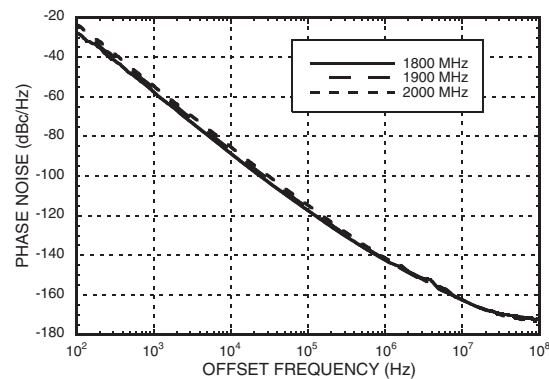

Typical Tuning Curves vs. Switch Position

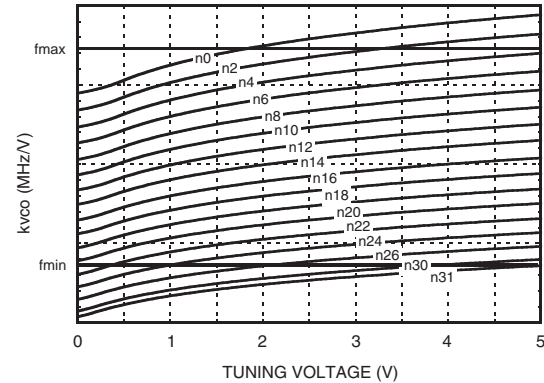

[1] Fractional Mode, 50 MHz Crystal, R=1, ~80 kHz Loop BW, (Loop filter values: Contact factory for component values) 2mA Charge Pump, -385µA Offset.

FRACTIONAL-N SYNTHESIZER WITH INTEGRATED VCO, 1815 - 2010 MHz

Free Running VCO Phase Noise (V_{TUNE} Set by AutoCal)

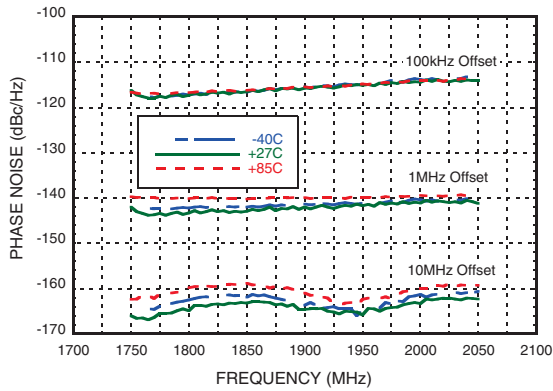

Typical VCO Tuning Voltage After Calibration

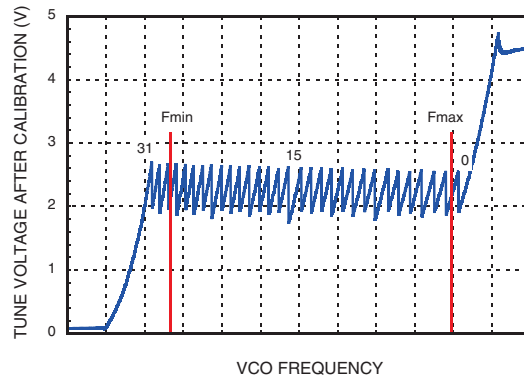

Typical VCO Sensitivity vs. Cap @ Fo Voltage

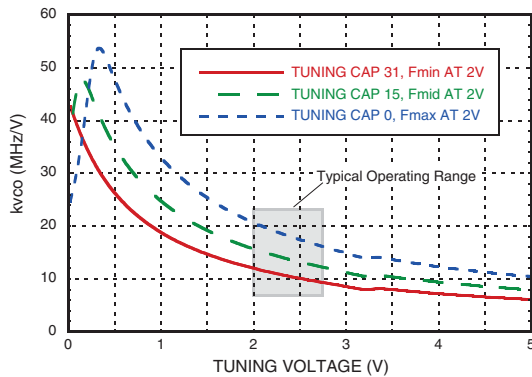

Typical Output Power - Narrow Band Match

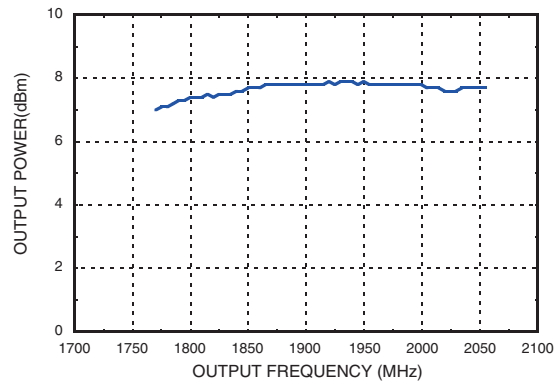
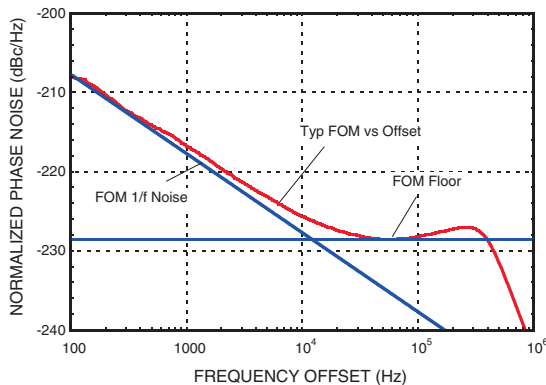

Figure of Merit



[1] Fractional Mode, 50 MHz Crystal, R=1, ~80 kHz Loop BW, (Loop filter values: Contact factory for component values) 2mA Charge Pump, -385µA Offset.



FRACTIONAL-N SYNTHESIZER WITH INTEGRATED VCO, 1815 - 2010 MHz

Pin Descriptions

Pin Number	Function	Description
1	AVDD	DC Power Supply for analog circuitry.
2, 5, 6, 8, 9, 11 - 14, 18 - 22, 24, 26, 34, 37, 38	N/C	The pins are not connected internally; however, all data shown herein was measured with these pins connected to RF/DC ground externally.
3	VPPCP	Power Supply for charge pump analog section
4	CP	Charge Pump Output
7	VDDCP	Power Supply for the charge pump digital section
10	RVDD	Reference Supply
15	XREFP	Reference Oscillator Input
16	DVDD3V	DC Power Supply for Digital (CMOS) Circuitry
17	CEN	Chip Enable. Connect to logic high for normal operation.
23	VTUNE	VCO Varactor. Tuning Port Input.
25	VCC2	VCO Analog Supply 2
27	VCC1	VCO Analog Supply 1
28	RF_N	VCO Divide by 2 RF Positive Output
29	RF_P	VCO Divide by 2 RF Negative Output
30	SEN	PLL Serial Port Enable (CMOS) Logic Input
31	SDI	PLL Serial Port Data (CMOS) Logic Input
32	SCK	PLL Serial Port Clock (CMOS) Logic Input
33	LD_SDO	Lock Detect, or Serial Data, or General Purpose (CMOS) Logic Output (GPO)
35	VCCHF	DC Power Supply for Analog Circuitry
36	VCCPS	DC Power Supply for Analog Prescaler
39	VCCPD	DC Power Supply for Phase Detector
40	BIAS	External bypass decoupling for precision bias circuits. Note: 1.920V \pm 20mV reference voltage (BIAS) is generated internally and cannot drive an external load. Must be measured with 10G Ω meter such as Agilent 34410A, normal 10M Ω DVM will read erroneously.

12

PLLS w/ INTEGRATED VCO - SMT

FRACTIONAL-N SYNTHESIZER WITH INTEGRATED VCO, 1815 - 2010 MHz

Absolute Maximum Ratings

AVDD, RVDD, DVDD3V, VCCPD, VCCHF, VCCPS	-0.3V to +3.6V
VPPCP, VDDCP, VCC1	-0.3V to +5.8V
VCC2	-0.3V to +5.5V
Operating Temperature	-40°C to +85°C
Storage Temperature	-65°C to 125°C
Maximum Junction Temperature	150°C
Reflow Soldering	
Peak Temperature	260°C
Time at Peak Temperature	40 sec
ESD Sensitivity (HBM)	Class 1B

Stresses above those listed under Absolute Maximum Ratings may cause permanent damage to the device. This is a stress rating only; functional operation of the device at these or any other conditions above those indicated in the operational section of this specification is not implied. Exposure to absolute maximum rating conditions for extended periods may affect device reliability.

Outline Drawing

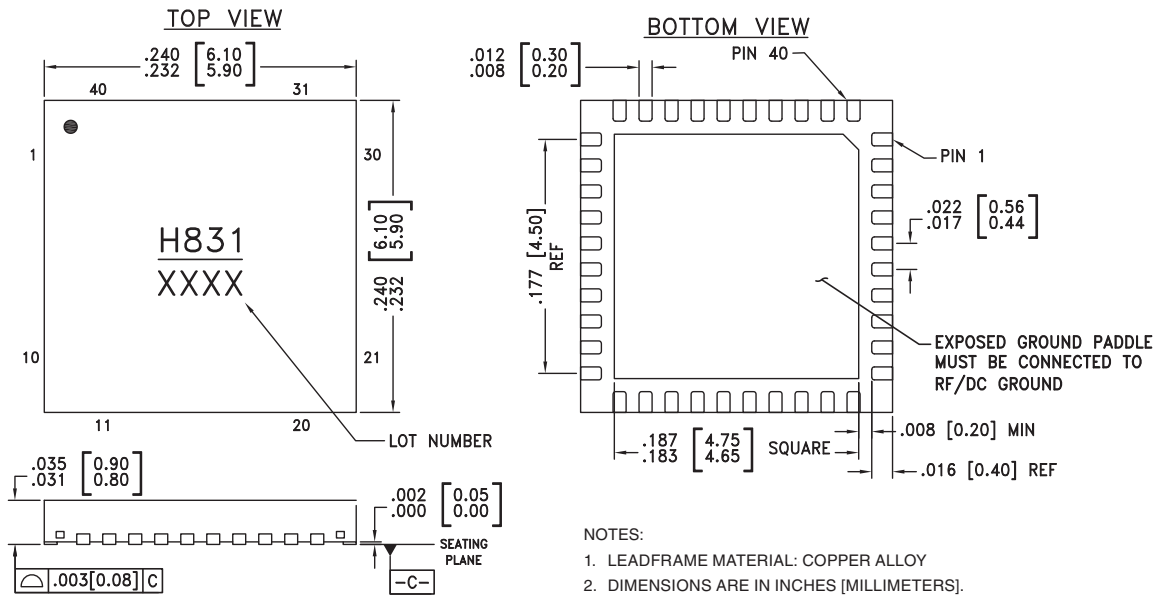

Package Information

Part Number	Package Body Material	Lead Finish	MSL Rating	Package Marking ^[1]
HMC831LP6CE	RoHS-compliant Low Stress Injection Molded Plastic	100% matte Sn	MSL3	H831 XXXX

[1] 4-Digit lot number XXXX



FRACTIONAL-N SYNTHESIZER WITH INTEGRATED VCO, 1815 - 2010 MHz

Evaluation PCB

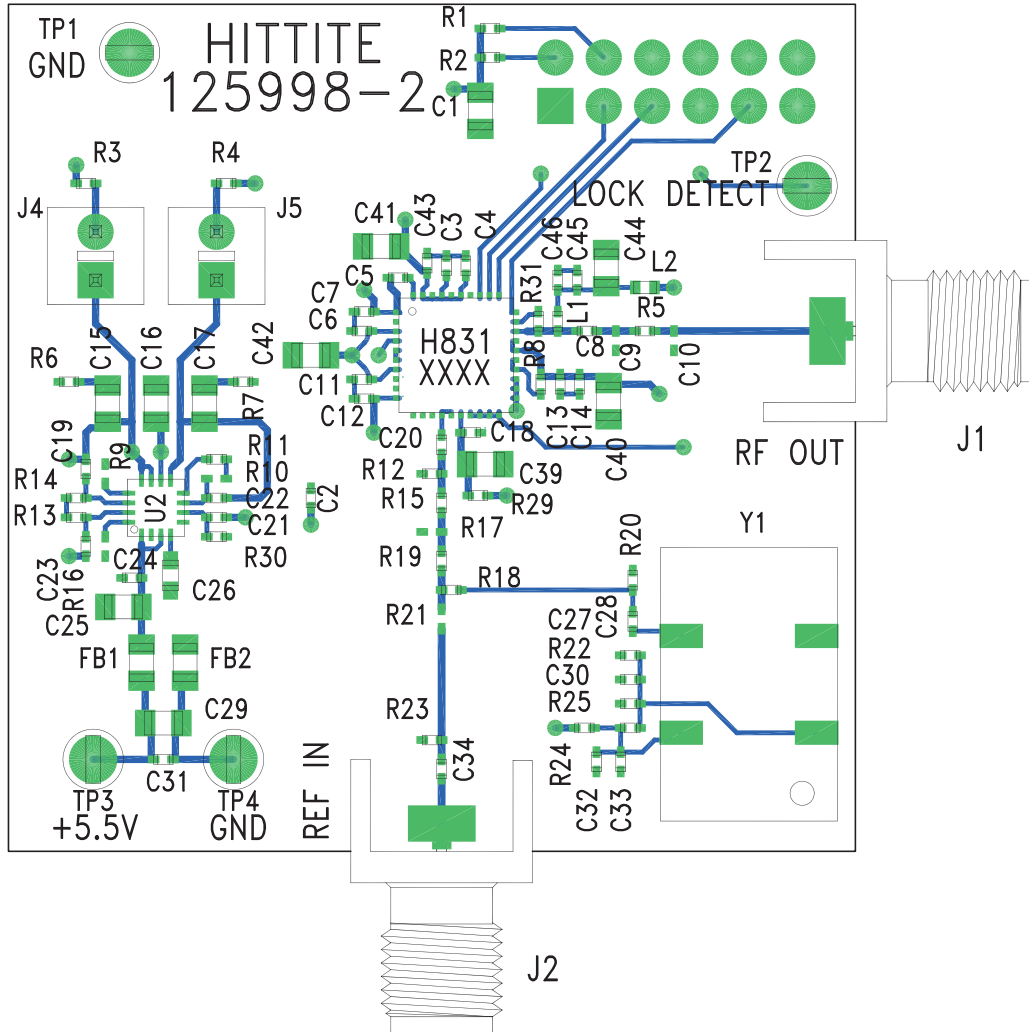

The circuit board used in the final application should use RF circuit design techniques. Signal lines should have 50 ohm impedance while the package ground leads and exposed paddle should be connected directly to the ground plane similar to that shown. A sufficient number of via holes should be used to connect the top and bottom ground planes. The evaluation circuit board shown is available from Hittite upon request.



FRACTIONAL-N SYNTHESIZER WITH INTEGRATED VCO, 1815 - 2010 MHz

List of Materials for Evaluation PCB 128147 [1]

Item	Description
J1, J2	PCB Mount SMA RF Connector
J3	Dual Row Terminal Strip
J4, J5	Connector Header
C1, C15 - C17, C25, C29	10 μ F Capacitor, 0805 Pkg.
C2, C3, C6, C7, C11, C12, C14, C18, C27, C43	0.47 μ F Capacitor, 0402 Pkg.
C4, C13	22 pF Capacitor, 0402 Pkg.
C5, C33	1000 pF Capacitor, 0402 Pkg.
C8	1.5 pF Capacitor, 0402 Pkg.
C19 - C24, C28, C30 - C32, C34	0.1 μ F Capacitor, 0402 Pkg.
C26	1.0 μ F Capacitor, 0603 Pkg.
C35	3300 pF Capacitor, 0402 Pkg.
C36	270 pF Capacitor, 0402 Pkg.
C37, C38	68 pF Capacitor, 0402 Pkg.
C39 - C42	4.7 μ F Tantalum Capacitor, 0805 Pkg.
FB1 - FB2	1000 Ohm 200 mA Ferrite Chip, 0805 Pkg.
R1, R2, R5, R11, R15, R18, R19	Zero Ohm Resistor, 0402 Pkg.
R3, R4, R6, R7	1 kOhm Resistor, 0402 Pkg.
R8	22 Ohm Resistor, 0402 Pkg.
R12, R20, R23	51 Ohm Resistor, 0402 Pkg.
R22, R25	20 kOhm Resistor, 0402 Pkg.
R24	10 Ohm Resistor, 0402 Pkg.
R26 - R28	1k Ohm Resistor, 0402 Pkg.
L1	12 nH Inductor, 0402 Pkg.
TP3, TP4	Test Point PC Compact SMT
U1	HMC831LP6CE PLL with Integrated VCO
U2	Low Noise Quad Adjustable Linear Regulator
Y1	3.3V, 50 MHz VCXO Crystal Oscillator
PCB [2]	125998 Evaluation Board

[1] Reference this number when ordering complete evaluation PCB

[2] Circuit Board Material: Rogers 4350 or Arlon 25FR and FR4

12

PLLS w/ INTEGRATED VCO - SMT



**FRACTIONAL-N SYNTHESIZER WITH
INTEGRATED VCO, 1815 - 2010 MHz**

Notes:

12

PLLS w/ INTEGRATED VCO - SMT